

Features

- $V_{CEO} > 60V$
- $I_C = 5A$ High Continuous Current
- $R_{SAT} = 30m\Omega$ for a Low Equivalent On-Resistance
- Low Saturation Voltage $V_{CE(SAT)} < 65mV @ I_C = 1A$
- h_{FE} Specified Up to 10A for High Current Gain Hold Up
- **Lead-Free Finish; RoHS Compliant (Notes 1 & 2)**
- **Halogen and Antimony Free. "Green" Device (Note 3)**
- **PPAP Capable (Note 4)**

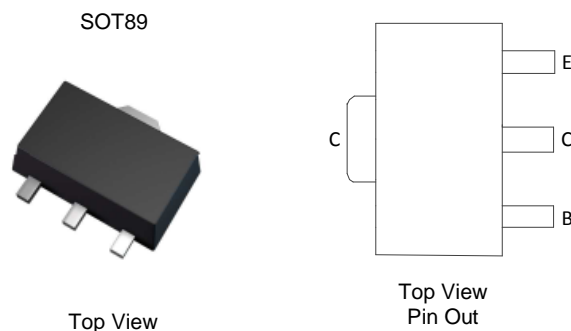

Application

- Emergency Lighting Circuits
- Motor Driving (Including DC Fans)
- Backlight Inverters
- Power Switches
- Gate Driving MOSFETs and IGBTs

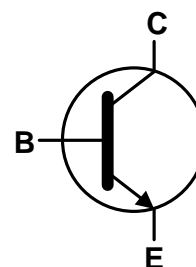

Device Symbol

Mechanical Data

- Case: SOT89
- Case Material: Molded Plastic. "Green" Molding Compound. UL Flammability Rating 94V-0
- Moisture Sensitivity: Level 1 per J-STD-020
- Weight: 0.05 grams (Approximate)

Maximum Ratings (@ $T_A = +25^\circ C$, unless otherwise specified.)

Characteristic	Symbol	Value	Unit
Collector-Base Voltage	V_{CBO}	150	V
Collector-Emitter Voltage	V_{CEO}	60	V
Emitter-Base Voltage	V_{EBO}	7	V
Base Current	I_B	2	A
Continuous Collector Current	I_C	5	A
Peak Pulse Current	I_{CM}	20	A

Thermal Characteristics (@ $T_A = +25^\circ C$, unless otherwise specified.)

Characteristic	Symbol	Value	Unit
Power Dissipation (Note 6)	P_D	1.5	W
Linear Derating Factor		12	mW/ $^\circ C$
Power Dissipation (Note 7)	P_D	2.1	W
Linear Derating Factor		16.8	mW/ $^\circ C$
Thermal Resistance, Junction to Ambient (Note 6)	$R_{\theta JA}$	83	$^\circ C/W$
Thermal Resistance, Junction to Ambient (Note 7)	$R_{\theta JA}$	60	$^\circ C/W$
Thermal Resistance, Junction to Leads (Note 8)	$R_{\theta JL}$	3.23	$^\circ C/W$
Operating and Storage Temperature Range	T_J, T_{STG}	-55 to +150	$^\circ C$

Thermal Characteristics and Derating Information

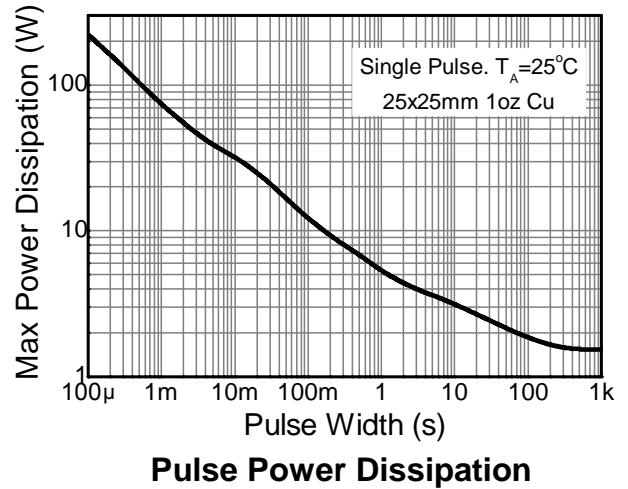
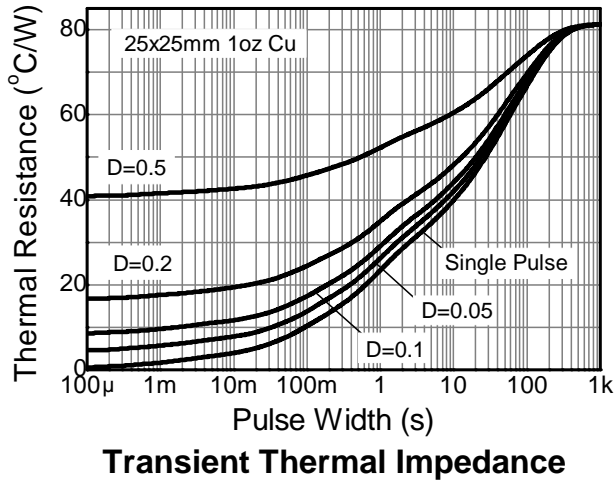
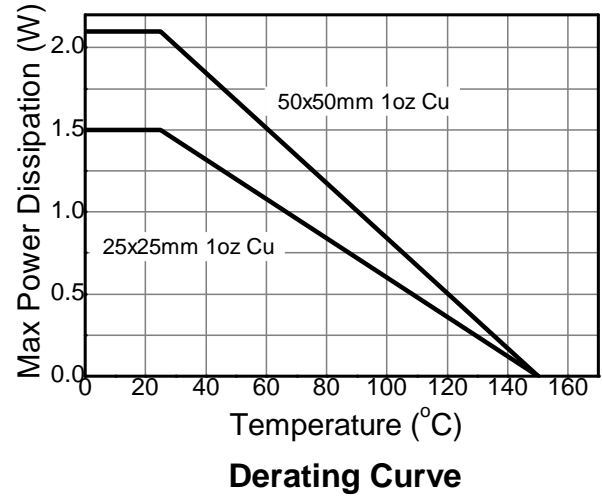
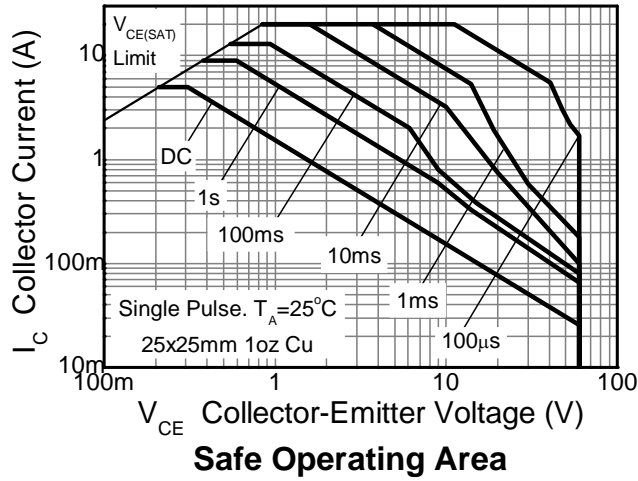

Electrical Characteristics (@T_A = +25°C, unless otherwise specified.)

Characteristic	Symbol	Min	Typ	Max	Unit	Test Condition
Collector-Base Breakdown Voltage	BV _{CBO}	150	190	—	V	I _C = 100μA
Collector-Emitter Breakdown Voltage (Note 10)	BV _{CER}	150	190	—	V	I _C = 1μA, R _B ≤ 1kΩ
Collector-Emitter Breakdown Voltage (Note 10)	BV _{CEO}	60	80	—	V	I _C = 10mA
Emitter-Base Breakdown Voltage	BV _{EBO}	7	8.1	—	V	I _E = 100μA
Collector Cutoff Current	I _{CBO}	—	< 1	50 500	nA nA	V _{CB} = 120V V _{CB} = 120V, T _A = +100°C
Collector Cutoff Current	I _{CER} R ≤ 1kΩ	—	< 1	100 500	nA nA	V _{CB} = 120V V _{CB} = 120V, T _A = +100°C
Emitter Cutoff Current	I _{EBO}	—	< 1	10	nA	V _{EB} = 6V
DC Current Transfer Static Ratio (Note 10)	h _{FE}	100	200	—	—	I _C = 10mA, V _{CE} = 1V
		100	200	300		I _C = 2A, V _{CE} = 1V
		55	105	—		I _C = 5A, V _{CE} = 1V
		20	40	—		I _C = 10A, V _{CE} = 1V
Collector-Emitter Saturation Voltage (Note 10)	V _{CE(SAT)}	—	17	30	mV	I _C = 100mA, I _B = 5mA
		—	35	55		I _C = 1A, I _B = 100mA
		—	40	65		I _C = 1A, I _B = 50mA
		—	90	125		I _C = 2A, I _B = 50mA
		—	170	230		I _C = 6A, I _B = 300mA
Base-Emitter Saturation Voltage (Note 10)	V _{BE(SAT)}	—	970	1100	mV	I _C = 6A, I _B = 300mA
Base-Emitter Turn-on Voltage (Note 10)	V _{BE(ON)}	—	910	1050	mV	I _C = 6A, V _{CE} = 1V
Transitional Frequency	f _T	—	130	—	MHz	I _C = 100mA, V _{CE} = 10V, f = 50MHz
Output Capacitance	C _{OBO}	—	31	—	pF	V _{CB} = 10V, f = 1MHz,
Switching Time	t _{ON}	—	42	—	ns	V _{CC} = 10V, I _C = 1A I _{B1} = -I _{B2} = 100mA
	t _{OFF}	—	760			

Note: 10. Measured under pulsed conditions. Pulse width ≤ 300μs. Duty cycle ≤ 2%.

Typical Electrical Characteristics (@ $T_A = +25^\circ\text{C}$, unless otherwise specified.)

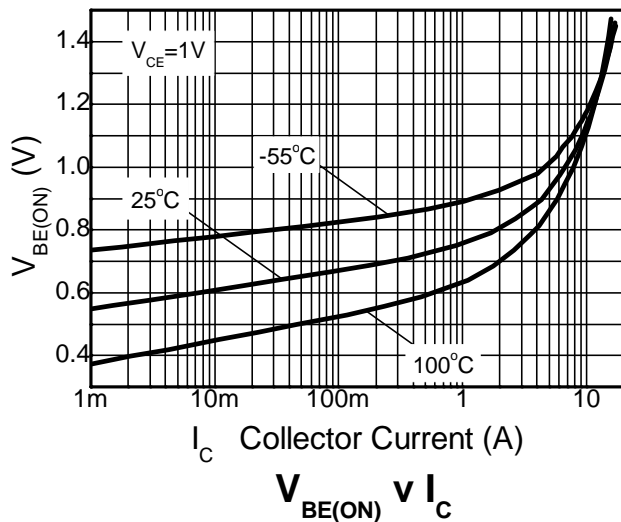
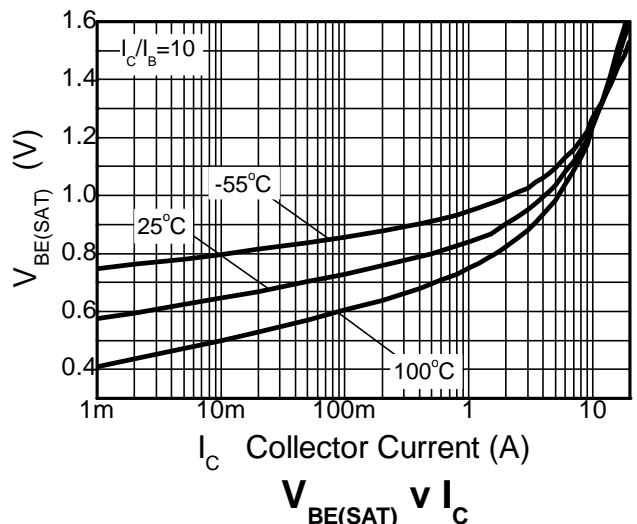
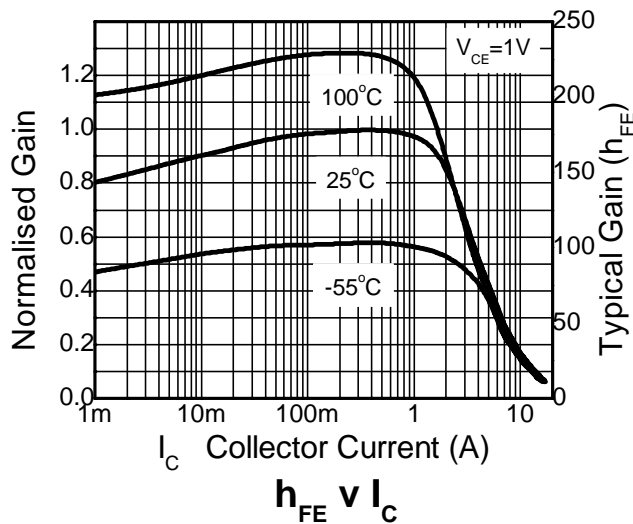
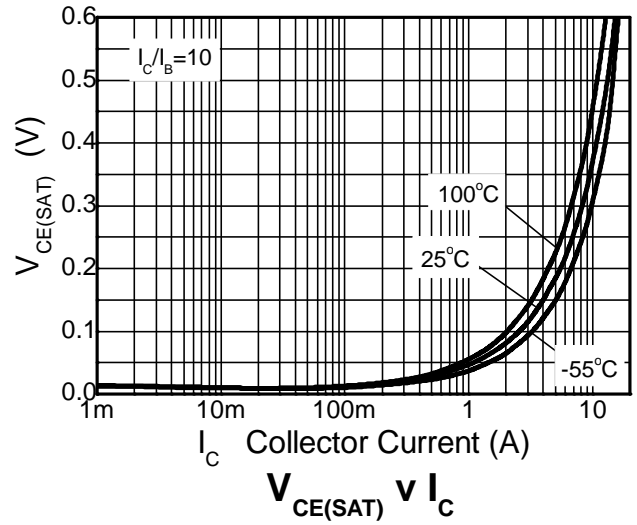
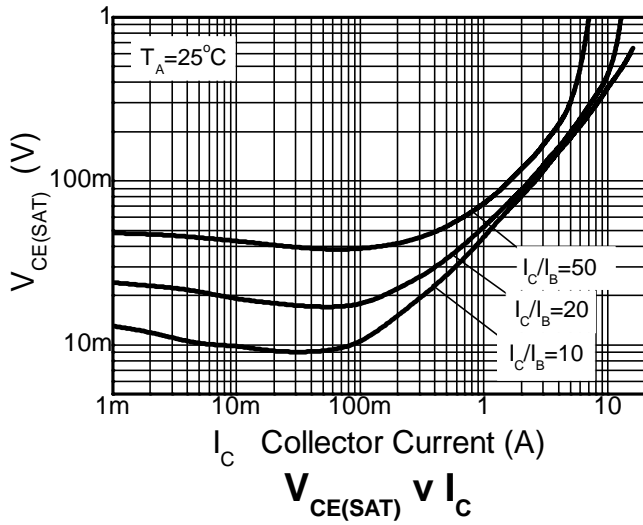

Package Outline Dimensions

SOT89

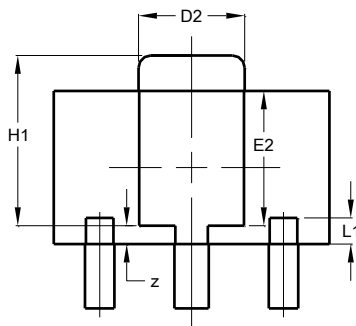
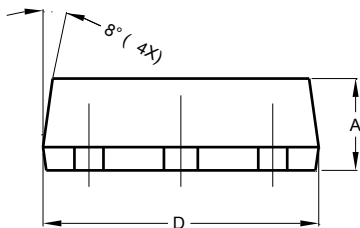
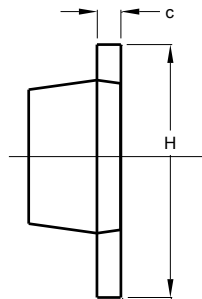
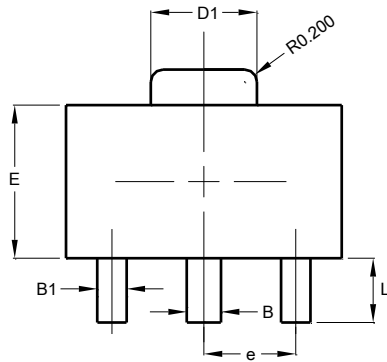

SOT89			
Dim	Min	Max	Typ
A	1.40	1.60	1.50
B	0.50	0.62	0.56
B1	0.42	0.54	0.48
c	0.35	0.43	0.38
D	4.40	4.60	4.50
D1	1.62	1.83	1.733
D2	1.61	1.81	1.71
E	2.40	2.60	2.50
E2	2.05	2.35	2.20
e	-	-	1.50
H	3.95	4.25	4.10
H1	2.63	2.93	2.78
L	0.90	1.20	1.05
L1	0.327	0.527	0.427
z	0.20	0.40	0.30
All Dimensions in mm			

Suggested Pad Layout

SOT89

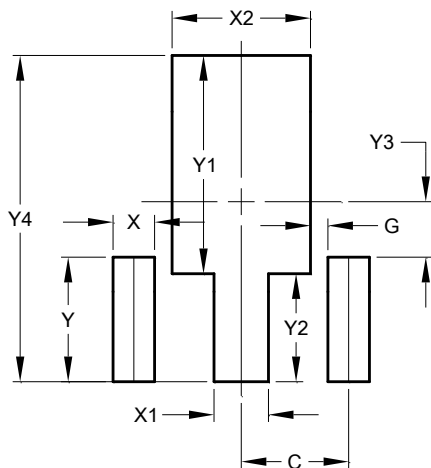

Dimensions	Value (in mm)
C	1.500
G	0.244
X	0.580
X1	0.760
X2	1.933
Y	1.730
Y1	3.030
Y2	1.500
Y3	0.770
Y4	4.530